

4C Surface Mounted Horizontal Mailboxes—3800 Series

Installation Instructions

With its high quality design and construction, Salsbury's 3800 series surface mounted 4C horizontal mailboxes will provide years of maintenance free service. Note: Salsbury's 3800 series surface mounted 4C horizontal mailboxes include a U.S.P.S. approved 4C horizontal mailbox unit, a matching enclosure and master commercial lock(s) for private access. For access by the U.S. Postal Service, contact your local postmaster for approval. **Please read this entire document before beginning installation.**

WARNING: Installation of the surface mounted 4C horizontal mailbox unit must be to a surface of sufficient load bearing strength. Attachment of the enclosure to the surface must be with fasteners that can adequately support the weight of the enclosure and mailbox unit. Installing to a deficient load bearing mounting surface and/or use of inadequate fasteners could cause the surface mounted 4C horizontal mailbox unit to fall from the surface possibly resulting in serious injury. See below for further information.

Installation Planning

1. Determine the horizontal location of each of the 3800 series mailbox units with its wall mount enclosure.
2. Consider the combined weights in the table below when designing the wall or selecting the appropriate fasteners and anchors to be used.
3. If attaching to studs in a custom built wall, determine the optimum location of the wall studs to which to fasten the enclosures. Frame the wall with wood studs. Build a robust wall.
4. If attaching to studs in an existing wall, determine the stud locations, and position enclosures to maximize the number of studs to which the enclosures will be attached.
5. If not attaching to studs, choose an appropriate high strength anchor, especially if attaching directly to drywall. When attaching to drywall, place the anchor and fastener as close as possible to the studs to which the drywall is attached.

3. No tenant mailbox compartment (interior bottom shelf surface) shall be positioned less than 28" AFF.
4. No parcel locker compartment (interior bottom shelf) shall be positioned less than 15" AFF.
5. At least one tenant mailbox compartment shall be positioned less than 48" AFF.

Types of Fasteners Used

Type A, Fig. 1 - If fastening into wood studs, use a #12x2" wood screw (not supplied). If fastening into metal studs or directly into dry wall, choose and use an appropriate wall anchor with screw.



Type B, Fig. 2 - To fasten the mailbox unit into the enclosure, use the #8x3/4" pan head self-tapping screws (supplied).

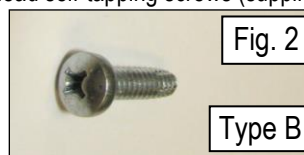

Weight of Mailbox Unit and Wall Enclosure

Mailbox Model	Total Weight - Lbs.	Mailbox Model	Total Weight - Lbs.
3816D	300	3816S	205
3815D	295	3815S	200
3814D	285	3814S	195
3813D	280	3813S	190
3812D	270	3812S	180
3811D	260	3811S	180
3810D	245	3810S	195
3809D	235	3809S	170
3808D	220	3808S	160
3807D	205	3807S	150
3806D	190	3806S	140
3805D	175	3805S	130

The weights above include the mailbox unit, the wall mount enclosure and 75 lbs. of mail.

Marking Distance from Floor and Stud Location

Mark the wall with a horizontal line representing the distance from the floor to the bottom surface of the enclosure. The distance from the bottom surface of the enclosure to the surface of the lowest compartment shelf or the parcel locker shelf is 2-7/16".

It is recommended that the enclosure be tied to studs due to its significant total weight including the mailbox unit. If attaching to studs, mark the wall with two (2) vertical lines representing two (2) wall studs to which the enclosure will be fastened.

If not attaching to studs, install appropriately strong anchors and fasteners to engage the outermost slots in the rows of slots in the rear panel.

USPS Height Regulations

1. The USPS arrow lock in the Carrier Access Door shall be located between 36" and 48" above the finished floor (AFF).
2. No tenant mailbox lock shall be located more than 67" AFF.

SALSBURY INDUSTRIES

18300 Central Avenue, Carson, CA 90746-4008
 Ph: 1-800-624-5269 Int'l Ph: 323-846-6700
 Fx: 1-800-624-5299 Int'l Fx: 323-846-6800
 www.mailboxes.com engineering@mailboxes.com

4C Surface Mounted Horizontal Mailboxes—3800 Series

Installation Instructions

Installing the Wall Fasteners

Install Type A wood screws, Fig. 3 (or anchors and fasteners) into all the outermost slots (or slots engaging wood studs) in the rear panel. Install two (2) of the Type A wood screws, not provided, (or anchors and fasteners, not provided) in the rear flange of the top panel and in the rear flange of the bottom panel so that the four (4) screws go through the elongated slots in the rear flanges and into the wood studs. See the “Screw Locations”, Fig. 4.



Screw Locations

Fig. 4 identifies the locations of the Type A fasteners that are used to attach the enclosure to the wall studs.

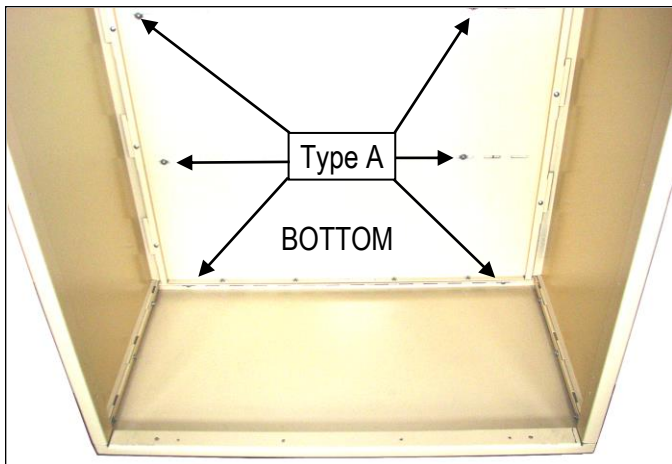
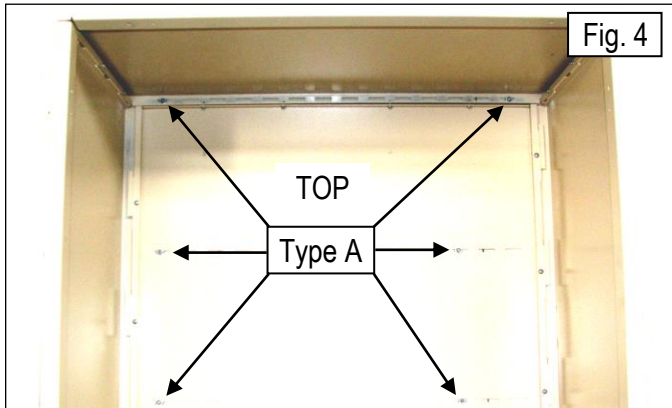

Installing the Mailbox Unit

Lifting and installing the mailbox unit into the enclosure is a two (2) person operation. Open appropriate compartment doors to provide handholds. Lift the mailbox unit and carefully slide it into the

enclosure until the front peripheral flange is flush against the front flanges of the enclosure. See Fig. 5.

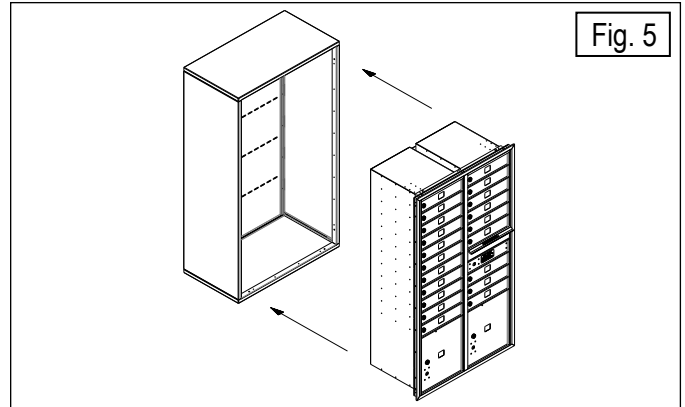

Fastening the Mailbox Unit to the Enclosure

Open the master door(s) of the mailbox unit until the hold-open rods at the top inside corners of the doors engage. Install Type B self-tapping machine screws (provided) in the flanges all around the four (4) sides of the mailbox unit just behind the master door(s). See the following illustrations to locate the flanges. Pilot holes are provided for the screws in the flanges. The double column mailbox unit shown uses four (4) screws each along the top and bottom flanges. The single column mailbox unit (not shown) uses only two (2) screws each along the top and bottom. See Fig. 6.

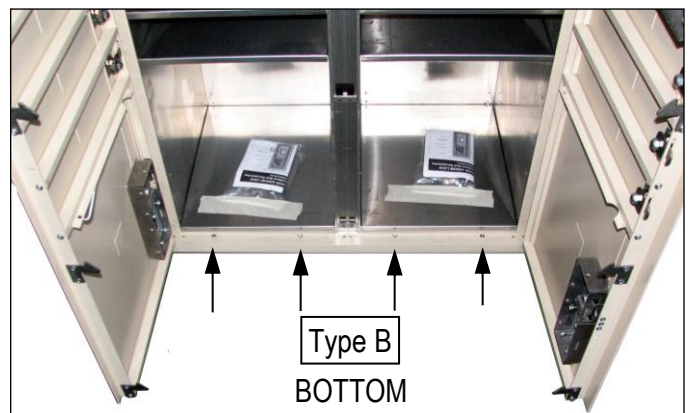
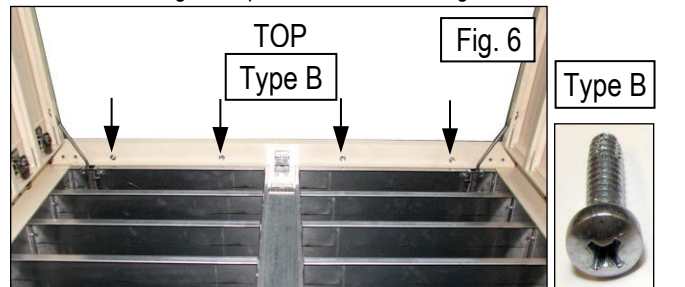

SALSBURY INDUSTRIES

18300 Central Avenue, Carson, CA 90746-4008

Ph: 1-800-624-5269

Int'l Ph: 323-846-6700

Fx: 1-800-624-5299

Int'l Fx: 323-846-6800

www.mailboxes.com

engineering@mailboxes.com

4C Surface Mounted Horizontal Mailboxes—3800 Series

Installation Instructions

The vertical flanges along the two (2) sides of the mailbox unit use variable quantities of screws depending on the height of the enclosure. The largest height enclosure is shown and uses seven (7) screws (provided) on each side. There should be a screw installed in each slotted hole. See Fig. 7 and Fig. 8.

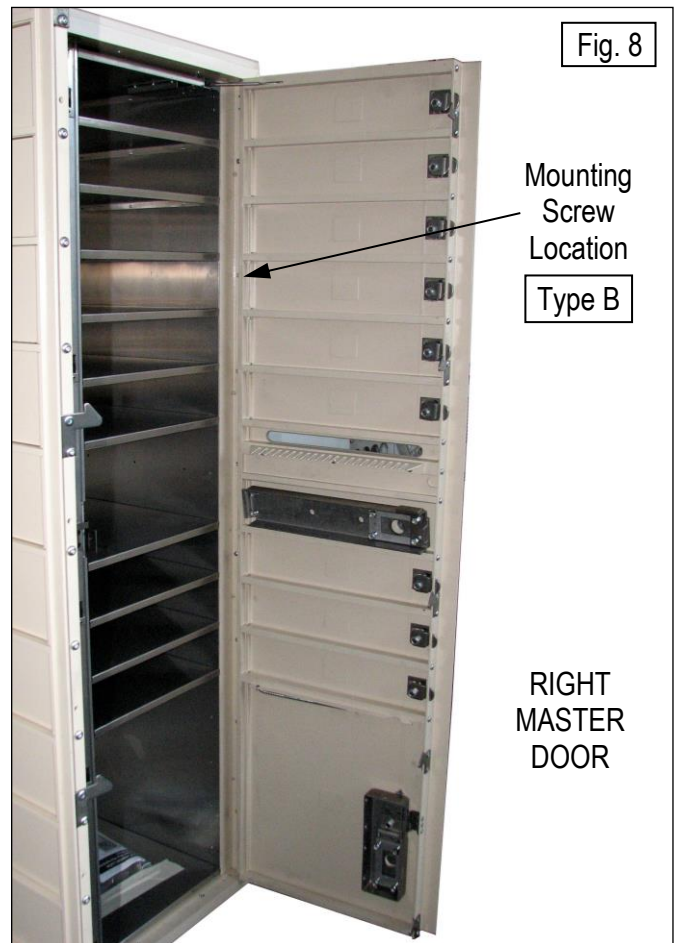
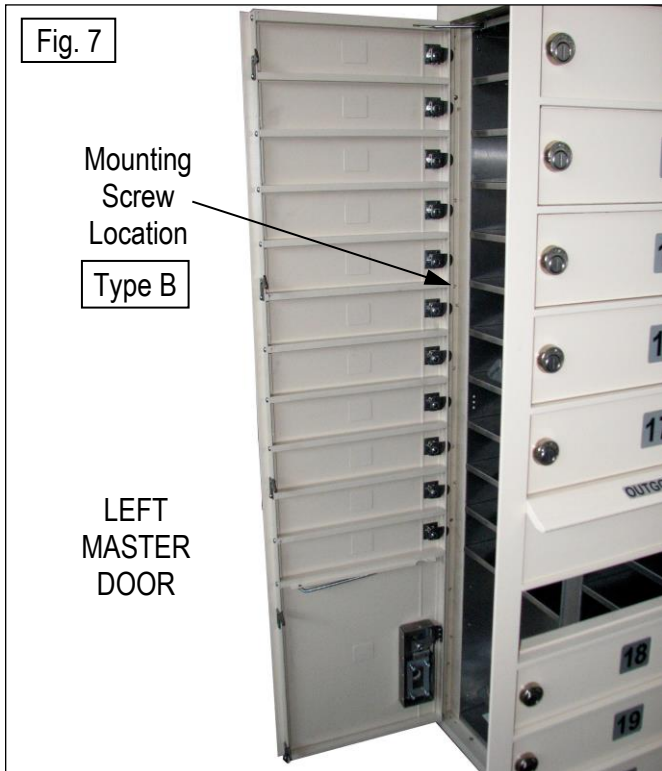

Completed Installation: Close and latch the master door(s) and all compartment doors.



SALSBURY INDUSTRIES

18300 Central Avenue, Carson, CA 90746-4008

Ph: 1-800-624-5269

Int'l Ph: 323-846-6700

Fx: 1-800-624-5299

Int'l Fx: 323-846-6800

www.mailboxes.com

engineering@mailboxes.com